



Manuel fialho
ÉVORA
MÁQUINAS AGRÍCOLAS



CARREGADORES FRONTAIS



PSI (COM PARALELOGRAMO)	Balde Aconselhado	Tipo de Braço	
AGRIFULL			
60 E e DT • 70 E • 80 E • 8056 e DT • 8066 • 8076 • 70 E DT • 80 E DT • 8066 DT • 8076 DT	1.50	B-1	
90 E e DT • 100 E • 110 E • 8096 e DT • 80106 • 80116	1.50	B-2	
100 E e DT • 110 E DT • 80106 DT • 80116 DT	1.75	B-3	
CARRARO			
6.1000 F • 6.1000 Agri-x	1.25	B-0	
8.1000 F DT • 8.1000 DT	1.50	B-0	
CASE INTERNACIONAL			
TCE 40 • TCE 45	1.25	B-000	
PJN 55 • PJN 75 • 2120 F • 2140 F • 2140 V (ST-DT) • 2140 PRO DT • 2150 V DT • JX 60 • JX 1070N JX 1095N	1.25	B-0	
585 • 685 • 745 • 784 • 785 • 795 DT • 845 • 885 • PJN 75 • CS 75 DT • CS 78 DT • CS 86 DT CS 94 DT • JX 70 • JX 75 • JX 80 • JX 85 • JX 90 • JX 95 • JX 70 U • JX 80 U • JX 85 U • JX 90 U • JX 1075 C • JX 1085 C • JX 1095 C	1.50	B-1	
585 DT • 685 DT • 745 DT • 785 DT • 845 DT • 856 XL DT • 885 DT • 956 ST • 1056 ST 4230 PRO DT • 4230 DT • 4240 PRO DT • 4240 DT • C 80 DT • JX 100 U DT • JX 1090 U JX 1100 U • CX 70 DT • CX 80 DT • CX 90 DT • CX 100 DT • MX 90 C DT • MXU 100 • MXU 110 100 Maxxum • 110 Maxxum •	1.50	B-2	
956 DT • 1056 DT • 1255 • 1455 • 5120 DT • 5130 DT • 5140 DT • 5150 DT 5130 PRO • 5140 PRO DT • 5150 PRO DT • MX 100 C DT • MX 110 DT • MX 120 DT • MXM 120 • MXU 115 • MXU 125 • CS 110 DT • 115 Maxxum • 120 Maxxum • 140 Maxxum •	1.75	B-3	
MXM 130 • MXM 140 • MXM 155 • MXM 175 • MXM 190 (#)	1.75	B-3	
CVX 120 • CVX 130 DT • CVX 150 DT • CVX 170 DT • CVX 1170 • CVX 1155 • CS 120 • CS 130 • CS 150 DT • MX 135 DT • MX 150 DT • MX 170 DT • MXU 135 Puma 165 • Puma 180 • Puma 195 • Puma 210	2.00	B-4	
CLAAS			
Nectis 227 F ST (sem cabina) • 247 F • 257 VL (sem cabina) • 267 FT	1.25	B-0	
617 DT • 657 DT	1.75	B-3	
697 ATZ • 697 ATZ (Tripuntal)	2.00	B-4	
DEUTZ			
Agrokid 35 DT • Agrokid 40 DT • Agrokid 45 DT • Agrokid 55 DT	1.25	B-000	
DX-3500 V DT • DX-3500 S DT • DX 3700 V DT • Agrolux 60 F DT / 70 F DT / 80 F DT Agroplus 60 • Agroplus 90 S • Agroplus F 90 • Agroplus F 100 • Agrocompac F-75 e F-100	1.25	B-0	
5006 DT • 5506 • 6006 • 6206 • 6207 • 6806 • 6807 • 7007 • DX-3700 F DT • DX-3700 S DT DX-3900 F DT • Agrottron 4.70 DT • Agrottron 4.80 DT • Agrottron 4.85 S DT Agrottron 80 DT / 85 DT / 90 DT • Agroplus 70 DT / 80 DT • Agroplus 57 / 67 / 77 / 87 Agro Lux 57 DT • Agro Lux 67 DT • Agro Lux 70 DT • Agrofarm 85 DT	1.50	B-1	

PSI (COM PARALELOGRAMO)	Balde Aconse- lhado	Tipo de Braço	
DEUTZ			
5506 DT • 6006 DT • 6206 DT • 6207 DT • 6806 DT • 6807 DT • D 7006 e DT • 7007 DT • 7206 DT D 7207 • 7506 e DT • 8006 e DT • 90006 e DT • 10006 e DT • DX 85 e DT • DX 86 e DT DX 90 e DT • DX 4.31 e DT • DX 4.50 e DT • DX 4.51 e DT • DX 3.50 DT • DX 3.60 e DT DX 3.70 e DT • DX 3.90 e DT • Agroextra 4.17 DT • Agroextra 4.57 DT • Agroplus 85 DT Agroplus 95 DT • Agrottron 100 DT • Agrottron 100 mk ³ • Agrottron K 90 • Agrottron K 100	1.50	B-2	
DX 6.05 e DT • DX 6.10 EA DT • A.P. 6.06 DT • 6.07 DT • A.P. 6.16 e DT • DX 110 ST • DX 120 ST DX 140 ST • A.X. 6.17 DT • DX 6.31 e DT • Agrottron 6.00 S DT • Agrosun 100 DT • Agrosun 120 DT Agrottron 6.05 S • Agrottron 6.20 tt DT • Agrottron 6.45 tt DT • Agrottron 105 DT Agrottron 105 mk ³ S.A DT • Agrottron 106 DT • Agrottron 106 mk ³ S.A. DT • Agrottron 110 DT Agrottron 115 mk ³ • Agrottron 118 mk ³ • Agrottron 120 DT mk ³ • Agrottron 128 DT mk ³ Agrottron 130 suspension • Agrottron K100 DT e Profiline • Agrottron K 110 Agrottron K 120 DT e Profiline • Agrofarm 100 • Agroplus 100 DT	1.75	B-3	
Agrostar 6.11 DT • Agrostar 6.38 DT • Agrostar 6.61 DT • DX 6.10 DT • DX 6.30 DT • DX 6.50 DT Agrosun 140 DT • Agrottron TTV 1160 • Agrottron 120 mk ³ S.A DT • Agrottron 135 mk ³ S.A Agrottron 135 mk ³ DT • Agrottron 140 DT • Agrottron 150 DT • Agrottron 165 mk ³ DT • Agrottron 165-7 Agrottron 175 DT • Agrottron 200 DT • Agrottron 180.7 Profiline	2.00	B-4	
EBRO			
6040 DT • 6045 DT • 6070 F	1.25	B-0	
44 • 45 • 48 • 55 • 155 • 160 • 470 • 460 • 6067 • 6070 • 6077 • 6079 • 8070 183 • 480 • 684 • 6067 DT • 6070 DT • 6077 DT • 6079 DT • 6080 DT • 6090 DT	1.50	B-1	
6095 • 6100 • 6115 • 6125 • 8070 DT • 8100 • 8110 • 8115 • 8135	1.50	B-2	
6095 DT • 6100 DT • 6115 DT • 6125 DT • 8100 DT • 8110 DT • 8115 DT • 8135 DT H-100 DT • H-115 DT • H-135 DT	1.75	B-3	
FENDT			
208 P DT • 209 P DT • 209 S • 270 P DT • 280 P DT • 280 S DT • 280 V DT	1.25	B-0	
Farmer 106 DT • 308 ST Elevado • 209 S (suspensão dianteira)	1.50	B-1	
108 S • 305 LS DT • 306 DT • Farmer 307 CI • Farmer 308 LSA DT • Farmer 309 C Farmer 409 Vario • Farmer 410 Vario • Farmer 411 Vario • 308 LS DT • 308 C DT • 309 • 309 DT 310 Vario • 311 ST • 311 Vario • 312 Vario • Farmer 410 Vario • 414 Vario • 415 Vario	1.50	B-2	
600 • 610 • 611 • 612 • 711 Vario • 712 Vario • 714 Vario • 716 Vario	1.75	B-3	
311 LSA • 312 LSA • 514 C • 614 LSA DT Favorit • 614 LSA DT • 718 Vario • 818 Vario	2.00	B-4	
FIAT			
4566 F • 4576 V • 5086 V • 5576 V • 5586 F e DT • 5586 V	1.25	B-00	
4576 F • 5566 F • 5576 F e DT • 566 EF • 666 EF ST • 6066 F e DT • 6076 F e DT • 6086 SV DT 6086 V • 6286 F DT • 7066 F e DT • 7076 F e DT • 7086 V DT 7286 F DT • 8066 F e DT • 8076 F e DT • 8286 F e DT	1.25	B-0	
566 E e DT • 640 e DT • 666 E • 766 EF • 766 E • 5556 DT • 55.66 DT • 6066 e DT • 7056 e DT 7066 • 8066 • 666 E DT • 766 E DT • 6588 e DT • 6594 DT • 7066 DT • 7088 e DT • 7090 e DT 8066 DT • 8088 e DT • 8090 e DT • 8590 e DT	1.50	B-1	
IMP. 780 e DT • 780 E e DT • 850 SUPER • 880 E e DT • 980 E • 1000 SUPER • 1080 E • 7294 DT 8294 e DT • 8894 DT • 9080 e DT • 9090 e DT • 10080 • 10090 • 11080 • 11090	1.50	B-2	
980 E DT • 1080 E DT • 10080 DT • 10090 DT • 11080 DT • 11090 DT F-100 DT • F-110 DT • F-115 DT • F-120 DT • F-130 DT • F-140 DT 1180 e DT • 1280 e DT • 1300 DT • 1380 e DT • 11590 e DT • 13090 e DT	1.75	B-3	
1580 • 1880 DT • 16090 DT • 18090 DT	2.00	B-4	

PSI (COM PARALELOGRAMO)	Balde Aconse- lhado	Tipo de Braço	
FORD			
3600 • 4000 • 4600 • 4610 • 4630 • 4630 F • 4830 F e DT • 5610 F e DT	1.25	B-0	
4630 DT • 5000 • 5600 • 5610 • 6410 • 6600 • 6610 • 6810 • 7000 • 7600 • 7610 5610 DT • 6410 DT • 6610 DT • 6810 DT • 7610 DT	1.50	B-1	
5640 e DT • 6640 e DT • 7740 • 7810 DT • 7840	1.50	B-2	
7740 DT • 7840 DT • 8210 DT • 8240 DT • 8340 DT • 8630 DT TW-10 ST • TW-15 ST • TW-25 ST	1.75	B-3	
TW-10 DT • TW-15 DT • TW-25 DT	2.00	B-4	
HURLIMANN			
H-476 XF DT • H-481 XF DT • 708 XN DT	1.25	B-0	
XA-607 DT	1.50	B-1	
H-468.4 DT • H-468.4 Prestige DT • H-476 DT • H-478 DT • H-4105 DT	1.50	B-2	
INTERNACIONAL			
574 • 584 • 585 • 644 • 674 • 744 • 785 • 885	1.50	B-1	
585 DT • 644 DT • 674 DT • 744 DT • 785 DT • 946 • 1046 • 955 • 956 • 1055 • 1056	1.50	B-2	
946 DT • 955 DT • 956 DT • 1046 DT • 1055 DT • 1056 DT • 1246 DT • 1255 DT • 1455 DT	1.75	B-3	
JOHN DEERE			
614 DT • 1040 V • 1850 V • 5315 V	1.25	B-00	
1035 EF • 1040 F • 1140 F • 1635 EF • 1845 F DT • 1850 F 2345 F DT • 5300 DT • 5310 DT • 5400 NDT • 5400 DT • 5410 N • 5515 F • 5615 F	1.25	B-0	
1040 e DT • 1140 e DT • 1630 • 1635 • 1640 • 1840 • 1850 F DT • 1850 e DT • 1950 F e DT 1950 e DT • 2020 • 2030 • 2035 • 2040 • 2040 F e DT • 2100 DT • 2120 • 2130 • 2135 • 2140 2450 F e DT • 2450 • 2650 F e DT • 2650 • 2850 • 2100 DT • 2200 DT • 2300 DT • 2400 DT • 5415 5500 e DT • 5500 N DT • 5510 DT • 5510 ST Highcrop elevado • 5515 DT • 1840 DT • 2040 DT 2140 DT • 2250 DT • 2450 DT • 2650 DT • 2850 DT • 5620 • 5720 • 5820	1.50	B-1	
2700 DT • 2800 DT • 3120 • 3130 • 3135 • 3140 • 3150 • 3300 X • 3340 • 3350 • 3400 X • 6100 DT 6200 DT • 6205 DT • 6300 DT • 6400 DT • 6010 DT • 6110 DT • 6210 DT • 6215 DT • 6310 DT 6410 DT • 6120 DT • 6220 DT • 6320 DT • 6420 DT • 6030 DT • 6130 DT • 6230 DT • 6330 DT • 6430 DT	1.50	B-2	
3140 DT • 3050 DT • 3150 DT • 3340 DT • 3350 DT • 3440 • 3640 DT • 3650 DT • 4040 • 4240 4440 • 6605 DT • 6506 DT • 6600 DT • 6800 DT • 6900 DT • 6510 DT • 6610 DT • 6810 DT • 6910 DT	1.75	B-3	
4050 • 4055 DT • 4240 S DT • 4255 DT • 4350 DT • 4430 • 4450 DT • 4455 DT • 4640 • 6520 DT 6620 DT • 6820 DT • 6920 DT • 6530 DT • 6630 DT • 6830 DT • 6930 DT • 7430 DT • 7530 DT 7600 DT • 7610 DT • 7700 DT • 7710 DT • 7800 DT • 7810 DT	2.00	B-4	
KUBOTA			
L-3600 • L-4200	1.25	B-000	
L-2550 DT • L-3130 DT • L-3250 DT • L-3300 • L-4630 • M-5400 DT Narrow	1.25	B-00	
5030 V • 5030 F • 6030 F e DT • 7030 F e DT • M 5700 Narrow • ME 5700 HS • M 8200 Narrow ME 8200 Narrow	1.25	B-0	
5030 e DT • 6030 e DT • M-5400 DT • M-5700 DT • M-6730 DT • M-6800 DT • M-7730 DT	1.50	B-1	
6950 e DT • 7580 DT • 7950 e DT • 8950 e DT • M1-75 e DT • M1-80 e DT • M1-85 e DT M1-90 e DT • M1-95 e DT • M1-100 e DT • M 105 S Dualspeed • M 108 S Dualspeed • M1-110 e DT M-8200 Standard • M-9000 DT • ME 9000 • M 105 Lowprofile	1.50	B-2	
M 120 DT • M 125 X	1.75	B-3	
K1-130 DT • K1-150 DT • K1-170 DT	2.00	B-4	



Manuel fialho
ÉVORA
MÁQUINAS AGRÍCOLAS



PSI (COM PARALELOGRAMO)	Balde Aconse- lhado	Tipo de Braço	
LAMBORGHINI			
Runner 350 • Runner 450 • R1 50	1.25	B-000	
R 235 DT • CRONO F 55 Target • CRONO F 70 Target	1.25	B-00	
775 F e DT • 775 V DT • 775 V Agile DT • 574-75-F CRONO • 660 V DT • 660 F e DT 880 S Agile DT • 990 S Agile DT • 880 F DT • 990 F DT PLUS • RS 75 • RV 90 RF 90 • PLUS 90 F • RF 100 • RV 90 DT • Crono 70 Target	1.25	B-0	
550 DT • 583 DT • 660 DT • 554-50 CRONO • 574-60 N DT • 674-70 N CROSS P.B. DT 674-70 SPRINT DT • 684.5 SPRINT • 774-80 N DT • 674-70 CROSS DT • 674-70 N CROSS DT e Grand Prix • R2 56 • R2 66 • R2 76 • R2 86 • R3 EVO 85 • R3 85 TB • R3 95 TB	1.50	B-1	
874-90 GP DT • 874-90 GP LS DT • 774-80 GP DT • Grand Prix 95 Target Premium 850 • Premium 950 • Premium 1060 • R3 85 • R3 95 T • R4 105	1.50	B-2	
956 DT • 1056 DT • 1106 DT • 1256 DT • 1306 DT • Premium 1300 DT • R3 EVO 100 • R4 110 • R5 130	1.75	B-3	
1506 DT • Formula 115 DT • Formula 135 DT • Champion 150 DT • R6 165-7	2.00	B-4	
Racing 165	2.00	B-4	
LANDINI			
Mistral 45 • 50 • 55	1.25	B-000	
60 Blizzard DT • 65 F DT • 65 V Advantage • 65 L Advantage • 75 F DT Advantage 65 F Advantage • 85 F • 85 GT Advantage • 85 L Advantage • 5830 DT • 5860 DT • 6530 F e DT 8530 F • Blizzard 50 • Rex 60 F • Rex 60 Speed Five • Rex 65 V • Rex 70 F e GT • Rex 80 GE e GT Rex 90 F • Rex 90 Deltashif • Rex 95 GT Speed Five • Rex 95 F Speed Five Rex 95 F Power Shuttle • Rex 100 F DT • Rex 100 GT Deltafour • Rex 105 DT Power Shuttle	1.25	B-0	
65 Blizzard • 85 Blizzard DT • 5500 e DT • 6550 DT • 7550 DT • 8880 DT • 8500 DT • 8830 DT Powerfarm 60 Speed Four • Powerfarm 95 ST • Ghibli 100 ST Vinhas • ATLAS 80 ST Vinhas Mythos 110 ST Deltafive • Atlas 70 DT • Atlas 80 DT • Atlas 85 DT • Atlas 90 DT • Atlas 100 DT Atlantis 80 DT • Atlantis 90 DT • Globus 70 Top DT • Globus 80 GT Top DT • Vision 105 ST elevado	1.50	B-1	
6880 DT • 8550 DT • 95 Blizzard DT • 95 Powerfarm DT • 105 Powerfarm DT • 6830 DT • 6860 DT 8860 DT • 9880 DT • Atlantis 100 DT • Globus 75 TOP DT • Ghibli 80 DT • Ghibli 90 DT Ghibli 100 DT • Mythos 100 DT • Mythos 110 DT Deltafive • VISION 80 • 90 • 100 • 105	1.50	B-2	
10000 MK II DT • 12500 MK II DT Legend 120 Techno • Vision 100 DT • Vision 105 Power Shuttle • Land Power 125	1.75	B-3	
14500 MK II DT Legend 115 DT • Legend 130 DT • Legend 140 DT • Legend 145 DT • Legend 180 TOP Legend 145 DT TDI Deltashift • Legend 165 DT • Landpower 165 DT • Power master 180 DT	2.00	B-4	
LG			
550 DT • 470 D DT • 530 D DT	1.50	B-1	
Mc CORMICK			
GM 45	1.25	B-000	
F 60 • F 60 GE • V 65 • F 70 • F 70 GE • F 70 XL F 80 • F 80 GE • F 80 XL • F 85 • F 85 XL • F 90 • F 100 • F 105 XL	1.25	B-0	
CX 70 • CX 80 • CX 90 • CX 100 • MC 80 • MC 90 • MC 100 • 85 C MAX • 95 C MAX CX 80 Xtrashift • CX 85 Xtrashift • CX 105 Xtrashift	1.50	B-2	
MC 100 • MC 105 • MC 115 DT	1.75	B-3	
MTX 110 • MTX 120 • MTX 125 • MTX 140 • MTX 155 • MTX 165 • MTX 175 • MTX 185	2.00	B-4	

PSI (COM PARALELOGRAMO)	Balde Aconse- lhado	Tipo de Braço	
MASSEY FERGUSON			
1335 DT • 1533 DT • 2415 DT • 2405 DT	1.25	B-000	
174 V e DT • 247 ST • 354 V	1.25	B-00	
154 F • 174 F e DT • 184 F e DT • 194 F e DT • 374 F e DT • 374 GE DT • 394 S DT • 394 DT 420 DT • 3245 FA DT • 3225 F DT • 3235 F DT • 3255 FA DT • 3330 FE • 3340 S DT 3340 FE s/cab DT • 3350 F DT • 3350 F cab DT • 3355 S DT • 3435 F • 3435 S • 3455 F • 3455 S	1.25	B-0	
165 • 265 • 267 • 275 e DT • 277 F • 277 • 290 curto • 675 • 690 • 352 Prestige DT • 3645 DT 3655 DT (Ano 2007) • 362 Moderns DT • 362 DT • 3235 ST • 3245 ST • 3255 HC ST • 4445 DT 4455 DT • 375 e DT • 390 e DT • 398 e DT • 178 • 188 • 285 e DT • 290 comprido e DT • 297 • 365	1.50	B-1	
393 HC • 1195 • 3050 DT • 3060 DT • 3065 DT • 3070 DT • 4225 DT • 4235 DT • 4245 DT 4255 DT • 4325 DT • 4335 DT • 4345 DT • 4355 DT • 4365 DT • 5425 DT • 5435 DT • 5455 DT 6120 DT • 6130 DT • 6140 DT • 6150 DT • 6455 Dynashift • 6465 Dynashift ST • 6475 DT	1.50	B-2	
399 S e DT • 399 ES DT • 1114 e DT • 1134 e DT • 2620 DT • 2640 DT • 2680 DT • 3080 DT 3085 DT • 3090 DT • 3095 DT • 3125 DT • 3235 DT • 3245 DT • 3255 HC DT • 3645 DT • 3655 DT 5460 DT • 5465 DT • 5470 Dyna-4 • 6160 DT • 6170 DT • 6180 DT • 6190 DT • 6245 DT • 6255 DT 6260 DT • 6265 DT • 6270 DT • 6280 DT • 6290 DT • 8110 DT • 4260 DT • 4270 DT • 4360 • 4370 6465 Dynashift • 6470 Dyna • 6480	1.75	B-3	
3245 HC DT • 3630 DT • 3650 DT • 3670 DT • 3690 DT • 6485 Dyna 6 • 6485 Dynashift DT 7480 Dynavt • 7485 Dynavt • 8130 DT • 8150 DT • 8210 DT • 8220 DT • 8240 DT • 8250 DT	2.00	B-4	
NEW HOLLAND			
TCE 40 • TCE 45 • TCE 50 • T 3040	1.25	B-000	
35.66 DT • 70.86 S DT	1.25	B-00	
62.86 F (ST-DT) • 82.86 F (ST-DT) • TN 55 DT • TN 65 N • TN 65 V • TN 75 N DT • TN 75 V DT TNF 90 A DT • TNF 95 A DT	1.25	B-	
TN 60 DA • TN 65 F DT • TN 70 • TN 75 A DT • TN 75 F DT • TN 75 D DT • TN 90 F DT • TN 80 F TN 95 F • TN 85 SA DT • TN 85 A • TN 95 A • TN 95 DA • TDD 75 • TDD 85 • TDD 95 TD 80 D DT • TD 85 D ST • TD 90 D DT • L-65 DT • L-75 DT • L -85 DT • L-95 DT TL 70 DT • TL 80 DT • TL 90 DT • 82.86 LP • 80.66 DT • TL 100 DT	1.50	B-1	
TN 75 S DT • TN 75 SA DT • TL 90 A DT • TL 100 A DT • TS 90 DT • TS 100 DT • TS 110 DT TS 100 A DT • TS 110 A DT • T 6010 • T 6020 DELTA	1.50	B-2	
7840 DT • 8240 DT • 8340 DT • M-100 DT • M-115 DT • TS 115 DT • TS 115 A DT • TS 125 A DT TS 135 A DT • TM 115 DT • TM 125 DT • T 6030 • T 6050 DELTA	1.75	B-3	
8160 DT • 8260 DT • 8360 DT • M-135 DT • TM-120 DT • TM 130 DT • TM-135 DT • TM 140 DT TM 150 DT • TM-155 DT • M 160 DT • TM-165 DT • TM 175 • TM 190 DT (#)	2.00	B-3	
TVT 135 • TVT 145 • TVT 150 • TVT 155 DT • TVT 190 T 7030 • T 7040 • T 7050 • T 7060 • T 7510 DT	2.00	B-4	

PSI (COM PARALELOGRAMO)	Balde Aconse- lhado	Tipo de Braço	
RENAULT			
7012 V • 7014 V	1.25	B-00	
5514 V • 55.14 LB • 7012 F e Export. • 7014 F e Export. • 8014 F e Export. • 501.4 • 551.4 S 7032 • Fructus 130 DT • Fructus 140 DT • Dionis 140 DT • Pales 210 ST • Pales 230 DT Pales 240 DT	1.25	B-0	
58.34 MX • 70.14 LB • Celtis 426 RX • Celtis 446 RX • Celtis 456 RX 7532 • 8532 • 9032 • 75.14 LS • 7514 • 751.4 • Ceres 85 X DT • Ceres 95 X DT • Ceres 330 DT 90-34 Tractor • Ceres 335 DT • Ceres 340 DT • Ceres 345 DT • Ceres 355 DT • Ceres 355 X DT Cergos 350 DT • Cergos 355	1.25	B-1	
70.34 • 75.34 • 85.34 • 651.4 • 652 • 681.4 • 781.4 • 851.4 E • 851.4 S • 751.2 • 751.4 (GP) • 751.4 S 80.14 TXT • 95.14 TX Blocamatic • 103-14 TX 16 • Ares 540 RX DT • Temis 550 X DT	1.50	B-2	
981.4 • 981 • 1181-4 • 106.54 TL Export. • ARES 556 X • 106.14 TX • 103.54 TS (Turbo) 103.54 TS (Tractonic) • Ares 610 RX • Ares 610 RZ • Ares 6.16 Z • Ares 6.26 Z Ares 620 RZ • Temis 610 X DT • Temis 630 Z DT	1.75	B-3	
103-54 Tractonic • 103-54 TA Export • 103-54 TS Export • 110-14 • 120-14 • 133-14 • 145.54 TX 120.54 TX DT • 155.54 TX • Ares 630 RZ • Ares 6.40 RZ DT • Ares 656 Z • Ares 696 RZ Ares 696 RZ Com engate frontal • Ares 710 RZ • Ares 816 RZ • Ares 815 RZ DT Ares 836 RZ • Temis 650 Z	2.00	B-4	
SAME			
Solaris 35 • Solaris 45 • Solaris 50 • Solaris 55	1.25	B-000	
Argon F 70 Classic	1.25	B-00	
Argon 70 Classic • Argon 75 F DT • Frutteto 60 II DT • Vigneron 62 DT • Vigneron 75 DT Frutteto 60 DT • Frutteto 75 e DT • Frutteto 75 II DT • Frutteto 85 II DT • Frutteto 90 II DT Frutteto 100 II DT • Golden 75 V DT • Golden 85 DT Dorado F 75 DT • Dorado F 90 DT • Dorado V 90 • Dorado F 100 DT Argon 50 • Argon 60 DT • Aster 60 e DT • Solar 50 e DT • Solar 60 e DT	1.25	B-0	
Aster 70 e DT • Corsaro 70 F DT	1.50	B-1	
Minitauro 60 DT • Minitaurus 60 DT • Dorado 70 DT • Dorado 85 DT • Dorado 86DT • Centurion 75 DT Centurion 75 Special DT • Centurion 75 Export DT • Centauro 70 Special DT Explorer 60 II Special DT • Explorer 70 Special P.B. e DT • Explorer 70 Special II P.B. DT Explorer 70 Special II DT • Explorer 70 Special e DT • Explorer 3 85 DT • Explorer 85 TB Explorer 95 TB • Explorer 80 II Special P.B.	1.50	B-1	
Explorer 75 New • 85 New • 95 New • 75 Classic • 95 Classic Explorer 80 Special e DT • 80 II DT • 80 II Top DT • 85 T e TB • 90 Special e DT • 90 II DT 90 II TOP DT • 90 II Special DT • 95 TB • Silver 80 DT • Silver 90 DT • Silver 105 DT Silver 100.4 • Silver 100.6 DT	1.50	B-2	
Mercuri 85 DT • Leopard 85 DT • Corsaro 70 DT • Saturno 80 DT • Leopard 85 DT Curto Leopard 90 DT • Laser 90 e DT • Panter 95 DT • Jaguar 95 e DT • Tiger 100 DT Jaguar 100 Export DT • Antares 100 DT	1.50	B-2	
Laser 100 e DT • Laser 110 e DT • Silver 110 DT • Iron 110 Hi line • Drago 120 DT • Laser 130 DT Búfalo 130 DT • Silver 130 DT • Antares 110 DT • Antares 130 DT • Explorer 3 100 DT	1.75	B-3	
Rubin 150 • Galaxy 170 • Iron 150.7 • Iron 165 • Iron 165.7	2.00	B-4	
Laser 150 DT • Titan 145 DT • Titan 160 DT • Titan 190 DT	2.00	B-4	

PSI (COM PARALELOGRAMO)	Balde	Tipo	
	Aconse- lhado	de Braço	
STEYR			
8090 DT • 9094 DT	1.50	B-2	
9115 DT • 9145 DT	2.00	B-4	
VALMET - VALTRA			
445 DT • 455 DT • 700 DT • 4100 DT • 4400 S DT • 4600 S DT • 3500 DT • A 85 • A 95	1.50	B-1	
655 ST • 665 DT • 755 ST • 800 DT • 805 ST • 865 e DT • 885 DT • 900 DT • N 101 • N 111 • N 121	1.50	B-2	
655 DT • 755 DT • 805 DT • 6200 DT • 6300 e DT • 6350 • 6400 e DT • 6600 e DT • 6550 S DT X 100 Articulado • 6850	1.75	B-3	
M 120 DT • 905 DT • 8050 DT • 8100 DT • 8100 S DT • 8350 DT	2.00	B-4	
8600 DT • 1180 S DT • 8150 DT • 8400 DT • 8550 DT • T 120 • T 130 • T 170 • T 190 • 8950	2.00	B-4	

(#) Só é possível a montagem deste tamanho de braço se retirados os contrapesos

OPCIONAIS	
Engate rápido de acessórios	
Par de engates para soldar no balde ou forquilha	
Bico de estrume para balde de areia	
Bico para balde de areia	
Bico para forquilha de estrume 820 mm	
Bico para forquilha de estrume 1100 mm	
Desengate rápido de válvulas de ligação (2)	
Desengate rápido de válvulas de ligação (4)	
Suplemento por 3ª função	
Suplemento por comando tipo joystick	
Suspensão hidráulica	
Engate rápido do acessório de accionamento eléctrico	
Suplemento por comando tipo joystick electrónico	
Montagem nas nossas instalações	

NOTA:

EM VIRTUDE DO CONTÍNUO APARECIMENTO DE NOVOS
MODELOS DE TRACTORES, PODE SUCCEDER QUE
DETERMINADOS MODELOS NÃO ESTEJAM PRESENTES
NESTA TABELA, SE ASSIM FOR.
CONSULTE-NOS!



Manuel fialho
ÉVORA
MÁQUINAS AGRÍCOLAS



CARACTERÍSTICAS

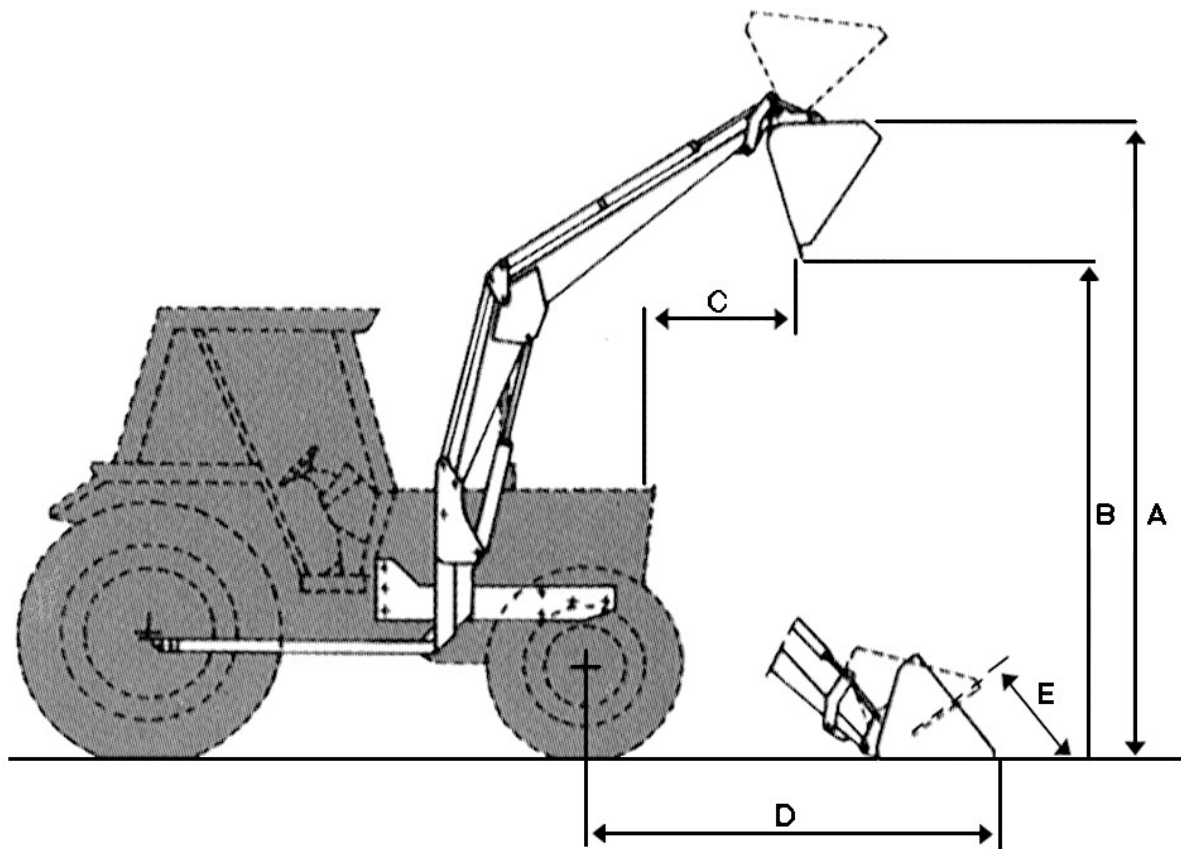

BRAÇO TIPO	A	B	C	D	E	FORÇA ARRANQUE	FORÇA ELEVAÇÃO
B0	3100	2200	630	2200	35°	1000 Kg	600 Kg
B1	3700	2780	650	2400	43°	1600 Kg	1000 Kg
B2	3940	3020	680	2450	43°	1600 Kg	1000 Kg
B3	4050	3130	620	2500	45°	2000 Kg	1300 Kg
B4	4220	3280	500	2670	40°	2200 Kg	1500 Kg



Manuel fialho
ÉVORA
MÁQUINAS AGRÍCOLAS



ACESSÓRIOS OPCIONAIS



		LARGURA	CAPACIDADE	
	BALDE DE AREIA	1.25 m	343 L	
		1.50 m	412 L	
		1.75 m	480 L	
		2.00 m	549 L	
		2.20 m	604 L	
		2.40 m	660 L	
	SUPLEMENTO BALDE DE AREIA A CEREAIS	1.50 m		
		1.75 m		
		2.00 m		
		2.20 m		
	BALDE MULTIFUNÇÕES	1.50 m	412 L	
		1.75 m	480 L	
		2.00 m	549 L	
	BALDE DE CEREAIS	1.60 m	716 L	
		1.80 m	805 L	
		2.00 m	895 L	
		2.20 m	984 L	
		2.40 m	1073 L	
	BALDE DE LIMPEZA	1.80 m	383 L	
		2.00 m	426 L	
		2.20 m	470 L	
	BALDE SOBRE-ELEVADO	2.00 m	870 L	
		2.20 m	961L	



Manuel fialho
ÉVORA
 MÁQUINAS AGRÍCOLAS











		LARGURA	CAPACIDADE	
	BALDE DE BETERRABA	1.80 m	729 L	
		2.00 m	809 L	
		2.20 m	890 L	
	BALDE DE BETERRABA SOBRE-ELEVADO	2.00 m	809 L	
		2.20 m	890 L	
	BALDE DE PEDRAS	1.50 m	461 L	
		1.75 m	538 L	
		2.00 m	630 L	
	BALDE DE BATATAS	1.80 m	921 L	
		2.00 m	1023 L	
		2.20 m	1126 L	
	CORTA - SILOS	1.50 m		
		1.75 m		
	BALDE BOCA DE PELICANO	1.50 m		
		1.75 m		
		2.00 m		
		2.20 m		
	FORQUILHA HIDRÁULICA DE DESENSILAR	1.50 m		
		1.75 m		
		2.00 m		
		2.20 m		
	FORQUILHA DE ESTRUME	1.25 m		
		1.50 m		
		1.75 m		
		2.00 m		
		2.20 m		

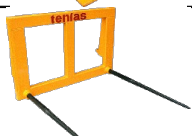

Manuel fialho
ÉVORA
MÁQUINAS AGRÍCOLAS



	FORQUILHA MECÂNICA DE PALETES	
	FORQUILHA HIDRÁULICA DE PALETES	
	FORQUILHA HIDRÁULICA DE PALETES BASCULANTE	
	FORQUILHA HIDRÁULICA DE TRONCOS (GRIFA)	
	FORQUILHA DE FARDOS CILINDRICOS	
	FORQUILHA DE FARDOS CILINDRICOS PLASTIFICADOS	
	PINÇA DE FARDOS CILINDRICOS PLASTIFICADOS	
	FORQUILHA HIDRÁULICA DE FARDOS RECTANGULARES	
	FORQUILHA MECÂNICA FARDOS RECTANGULARES	
	FORQUILHA PARA CANA DE AÇÚCAR	